



## The NMEA 0183 Information sheet

Everything you wanted to know about  
NMEA 0183  
(but were afraid to ask)

- Understanding the NMEA 0183 specification
- How to connect NMEA 0183 devices together
- How to understand NMEA 0183 sentence formats



Issue 4

# Contents

<b>Important Notices</b>	<b>4</b>
<b>Notices</b>	<b>4</b>
<b>Feedback!</b>	<b>4</b>
<b>NMEA 0183 Introduction</b>	<b>4</b>
The basics	4
Electrical specification	5
NMEA 0183 v2.x and v3.x Talker	5
NMEA 0183 v1.x Talker	5
Other Talkers	5
NMEA Talker Limitations	5
Listener specification	6
Communication specification	6
The different versions of the	7
NMEA 0183 standard	7
Format changes	7
Introducing ISO-Drive	7
<b>The Actisense product range</b>	<b>8</b>
PC OPTO-Isolation cables	8
NMEA Data Multiplexers / Combiners	8
NMEA Autoswitches	8
NMEA Buffers	8
NMEA Gateway - NMEA 0183 to PC USB	8
<b>Connecting NMEA talkers to NMEA Listeners</b>	<b>9</b>
<b>Differential NMEA talker</b>	<b>9</b>
Case (1): Standard differential NMEA 0183 v2.0+ Listener	9
Case (2): Single-ended NMEA Listener	9
<b>Single-ended NMEA talker</b>	<b>10</b>
Case (1): Standard differential NMEA 0183 v2.0+ device	10
Case (2): Single ended NMEA interface devices	10
<b>Connecting a computer to an NMEA 0183 network</b>	<b>11</b>
Recommended method for connecting a PC to an NMEA 0183 Network	11
Testing an NMEA 0183 computer connection with Actisense NMEA Reader	12
Example data using an Actisense talker device	12
<b>NMEA 0183 Sentence Format</b>	<b>13</b>
DBT – Depth Below Transducer	13
DPT – Depth	13

# The NMEA 0183 Information sheet - Issue 4

MTW – Mean Temperature of Water	14
VHW – Water Speed and Heading	14
VLW – Dual Ground/Water Distance	14
NMEA Version 3 Approved Sentence Formatters	15
<b>NMEA Contact Information</b>	<b>16</b>
<b>Company Information</b>	<b>16</b>

## Important Notices

This **Actisense** document is for informational purposes only, and to the best of our knowledge, the information contained within is accurate and true. Any use of the information contained within this document is solely at the user's own risk.

No responsibility will be accepted for any personal injury or damage to a boat or its connected equipment resulting directly or indirectly from information contained within.

Navigational equipment used on board a boat can be critical to the safe passage of the vessel, so if in doubt, contact an expert equipment installer before making any modifications to your current system.

Unfortunately, we cannot published the entire NMEA 0183 standard here, as it is copyrighted by NMEA. A full copy of this standard is available for purchase at the NMEA web site - see the [NMEA contact details](#) at end of document. We would recommend anyone designing equipment for connection to an NMEA 0183 network to obtain an official copy.

## Notices

When using this document, keep the following in mind:

The information contained in this document and any specifications thereof may be changed without prior notice. To obtain up-to-date information, contact Active Research Limited (refer to the [Contact Information](#) section) or visit the Actisense website ([www.actisense.com](http://www.actisense.com)).

Active Research Limited will not be liable for infringement of copyright, industrial property right, or other rights of a third party caused by the use of information or drawings described in this document.

All rights are reserved: The contents of this document may not be transferred or copied without the expressed written permission of Active Research Limited.

## Feedback!

This document has been produced from some of the knowledge and experience gained by Actisense from many years of experience in NMEA interfacing.

Please report any errors, omissions or inaccuracies directly to Actisense - we intend this document to be a useful resource tool to installers new to NMEA 0183 and inevitably we may have missed out the vital piece of information that they may have required to achieve a working NMEA 0183 system.

## NMEA 0183 Introduction

The National Marine Electronics Association (NMEA) developed a standard over 20 years ago that defines the interface between various pieces of marine electronic equipment and navigational computers, allowing them to talk together and share vital information.

The NMEA 0183 standard slowly became the common method by which marine electronics devices could talk to one another. The standard specifies both the electrical connections that make up an NMEA system, the communications method of transmitting the data, and the format of the data sentences that carry the NMEA information.

The NMEA 0183 standard is a purely digital data transmission scheme, using '1's and '0's in a binary format, to communicate a digital representation of the required information (depth, speed etc.) to a connected device.

The need for NMEA 0183 evolved from the earlier "NMEA 0180" and "NMEA 0182" standards. Because they differ in baud rate and transmission parameters from NMEA 0183, they are completely incompatible with NMEA 0183.

Similarly, the new "NMEA 2000" standard is totally different, and the two networks cannot be mixed without using a special gateway device to convert between the two standards such as the Actisense NGW .

### The basics

The NMEA standard defines the electrical signalling, data protocol and sentence formats for a 4800 baud serial data bus.

NMEA data is transmitted from an information source such as a GPS, depth sounder, or gyro compass etc. These data sending devices are called "**Talkers**".

Equipment receiving this information such as a chart-plotter, radar, PC or NMEA display is called a "**Listener**".

Each NMEA 0183 data bus shall have only a single talker but may have many listeners. The talker section of this document explains why this is the case.

## Electrical specification

The latest specifications for NMEA 0183 (version 2 and onwards) should, as a minimum, meet the requirements of the computer standard "RS422" (Standard EIA-422-A). They use +5 / 0 volt signalling, which is low voltage and easy to interface to computer equipment.

However, voltage levels present on an NMEA0183 network can be much greater - up to +/- 15 volts, particularly where older equipment is used, as the original version 1 specification used +/- 12-15 volt signalling.

Thus, all NMEA 0183 inputs conforming to v2.0 and higher should be capable of receiving +/- 15 volt differential signals without suffering damage.

The NMEA 0183 specification also requires that all receiving equipment must be opto-isolated; this opto-isolation requirement reduces the chances of interference and removes the problem of ground loop effects.

All connections should be made using twisted pair cabling, with a shield. To prevent ground loops, the shield should only be connected at one end - NMEA specifies that the shield should be connected to the Talker chassis.

## NMEA 0183 v2.x and v3.x Talker

As specified in RS422, version 2 and newer NMEA connections are labelled "A", "B" and Shield. Sometimes the signals are label Data + and Data -, these relate to NMEA A and NMEA B respectively.

The signal states provided by the Talker are those specified in EIA-422-A. This states that the logical "1" or STOP bit state is defined by a negative voltage on line "A" with respect to line "B". A logical "0" or START bit is defined by a positive voltage on line "A" with respect to line "B".

A pictorial representation of an RS422 type talker can be seen in the diagram below:

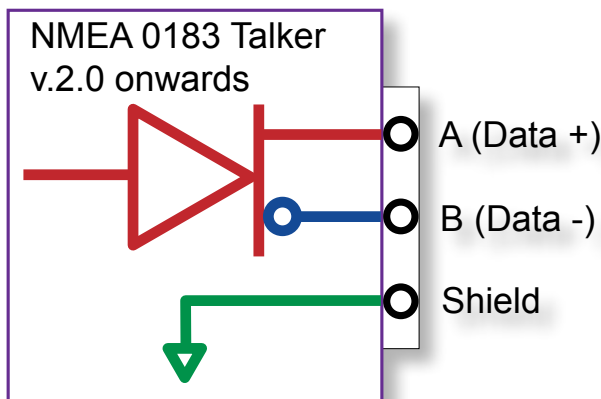

The A is the regular output from the amplifier, and the B is the "inverted" output. The shields of all LISTENER cables shall be connected to the TALKER chassis only and shall not be connected at each LISTENER.

In practice, this means line A is zero volts and line B is at 5 volts on an NMEA output when a logical "1" is present. For a logical "0" line A is at 5 volts and line B is at 0 volts. These voltages would be present only when no load is attached.

## NMEA 0183 v1.x Talker

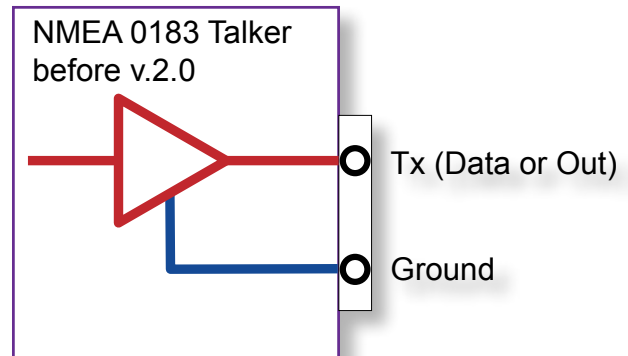

NMEA 0183 version 1 talkers used slightly different connection methods and signal levels. Devices had just one "NMEA" data line ('Tx' 'Data' or 'Out'), and used the ground as the other line - similar to a computer serial port. This connection method is referred to as "single ended" instead of the "differential" method used by NMEA 0183 v2.0 devices.

Version 1 talkers also had signal levels similar to that used in the computer 'RS232' standard. Here, the data signalling voltage was up to +/- 15v, and the logical "1" or STOP bit state is defined to be within the range -15 to +0.5v. The logical "0" or START bit was defined to be within the range +4.0v to +15.0v.

## Other Talkers

Many devices are produced that are fully compliant with the NMEA 0183 standard. Most simply label the outputs as "DATA" or "TX", and use the system ground line as the "B" line, as per the version 1 standard, but often the drive voltage is 5 volts, as used in version 2. Many of these talkers are labelled as version 2, but in this case they are referring to the contents of the data format, not the talker. Another limitation of these circuits is that they often use low power driver chips, and thus can often only talk to one listener instead of many. This means that an "NMEA Buffer" must be used to drive multiple listeners

## NMEA Talker Limitations

NMEA Talker outputs cannot be turned off, or switched into a receive mode, which means that the outputs are continuously driven.

This is why only one talker can be present on a single NMEA 0183 network at any one time. To combine data buses, you must use a multiplexer, such as the Actisense NDC. This safely receives the data from multiple talkers, and combines it together into a single stream.

Two or more Talkers are simply not possible on the same data line as they are not synchronised to each other, and will attempt to 'talk' at the same time (over each other). It is also likely that one Talker will have a stronger drive circuit, and the other talker will not even get to send anything.

This will result in corruption or total loss of the NMEA data, and potentially in disaster if valuable data such as navigation information is lost or corrupted so that it is incorrect and/or misleading.

Connecting two talkers together can even lead to one or both of the Talkers becoming damaged.

A Talker can be connected to multiple Listeners, but often many talkers used in electronic devices on the market do not provide enough driver current to talk to more than one or two listeners at one time, thus special NMEA amplifiers or "buffers" need to be employed.

## Listener specification

A listener receiver must be design to operate with a minimum differential input voltage of 2.0 Volts, and not take more than 2.0mA from the line at that voltage. The NMEA standard document shows a circuit that will meet this requirement. Actisense has designed it's own OPTO input circuit which exceeds this requirement, extending the range of which good data may be successfully received.

A Listener must also be OPTO isolated to prevent ground loop problems. Again, many manufacturers have not implemented this and this has caused more problems in installations, as connecting together two grounds of two systems can be a major source of faults on installations.

It also causes major issues when connecting a version 2.0 Talker to a version 1.x listener, as connecting the "B" line to the ground causes current to flow every time the "B" line tries to go to +5 volts.

Listeners must also be tolerant of the higher voltages used in NMEA version 1 signalling.

*See 'ISO-Drive' section for a solution to this problem.*

## Communication specification

The data communication specification for NMEA version 1, 2 and 3 is essentially the same as RS232 with the settings: 4800 baud, 1 start bit, 1 stop bit and "No Parity".

In addition, NMEA 0183 version 3.0 added a new baud rate of 38400 baud. This is known as "NMEA 0183-HS" This was to allow for the latest ARPA and AIS equipment which require a higher baud rate link to send the larger quantity of information they produce in a timely manner.

The data sent is all in printable ASCII form (data bit 7 is always zero in NMEA 0183 data transmissions, and all characters should be between ASCII HEX 20 and HEX 7E), so may be viewed directly on a PC "terminal" type program (like 'HyperTerminal') - even though what is seen may not make much sense.

### Note:

NMEA 0183-HS or NMEA 0183 v3 is in **no way related** to the new NMEA 2000 standard (as is incorrectly suggested by some manufacturers), which uses a totally different electrical connection standard that is not compatible with NMEA 0183 in any way.

If you require to convert between NMEA 0183 and the new NMEA 2000 network, the [Actisense NMEA 2000 Gateway](#) will allow full bidirectional conversion between these two very different standards. Please visit the [Actisense website](#) for full details.

## The different versions of the NMEA 0183 standard

As the NMEA 0183 specification has slowly evolved over the years, connecting one device to another is not always a simple matter.

The situation is further complicated, as many manufacturers still use the old ("single ended") method of connection because it is cheaper to implement.

So how can an older type NMEA device be connected to a newer type device? **Care is needed** – it is possible to damage or overload the output of a newer differential device if it is incorrectly connected to an older device. This is because the older devices used ground as the return, whereas the newer devices actually drive the NMEA “-/B” line between 5v and 0v. Thus, connecting this output to ground will result in high currents being drawn by the driver instrument, resulting in potential overheating and damage to the driver circuits.

See pages 8 and 9 for connection diagrams relating to interconnection of different NMEA 0183 network and device configurations.

### Format changes

The data format is largely the same between versions of NMEA, with v2.0 adding some extra sentence strings, and removing older (redundant) sentence strings from the specification.

There are however problems when interfacing between version 1 and 2 NMEA 0183 where some sentence formatters were changed between the two standards. This means that some older equipment will not work properly when receiving data from equipment sending version 2.0 data. These changes are too fundamental and detailed to go into in this document.

### Introducing ISO-Drive

To solve all the above fundamental interfacing problems, Actisense introduced ISO-Drive outputs on all new products. These outputs provide the essential isolation that will keep a system safe when mixing products from different manufacturers on a complex marine bus. If the ISO-Drive “B” line is connected to ground, no current will flow and the system is safe.

## The Actisense product range

**Actisense** produces a full range of products to solve all NMEA interfacing and interconnection requirements, including:

### PC OPTO-Isolation cables

The **Actisense** PC-OPTO range allows a PC to safely receive data from an NMEA 0183 network, protecting against high voltage spikes and preventing dangerous ground loops.

The cable converts neatly between the differential system used on the NMEA 0183 network and the “single-ended” RS232 system to provide the best quality of data for the PC port. See section “Connecting a computer to your NMEA 0183 network” for more details.

### NMEA Data Multiplexers / Combiners

The **Actisense** NDC product range can allow multiple “**Talkers**” to easily share their data with other NMEA 0183 “**Listener**” devices.

Some NDC models allow for filtering of the NMEA 0183 data to remove any unwanted sentences. A wide range of input / output Baud rates can be set to match any NMEA device. Computer users with a USB port are catered for with the later variants in the range, either being supplied with a USB cable or having upgrade capability. Autoswitching functionality has also been added to later variants of the NDC, see the Autoswitching section below.

### NMEA Autoswitches

The **Actisense** NSW-1 (and some of the NDC range) can enable automatic switching of two or more NMEA 0183 source (“**Talker**”) devices to select the highest priority device with valid data - in effect - automatic backup protection.

This can be used to select the highest priority GPS unit, and automatically switch to the next highest priority GPS device if the first fails for one of a number of reasons.

### NMEA Buffers

The **Actisense** NBF product range provides multiple ISO-Drive outputs to allow several NMEA 0183 devices on separate systems to safely receive the data from one source. The signal is buffered, amplified and isolated to meet the needs of any NMEA 0183 network. If you require more than one source (“**Talker**”) of data, an **Actisense** NDC can easily be used. An NBF connected to the output of an NDC will provide multiple isolated data streams from multiple inputs.

### NMEA Gateway - NMEA 0183 to PC USB

The USG product range is the USB to Serial (NMEA 0183) gateway. This provides a totally isolated input and output to connect a PC standard USB port to an NMEA 0183 network. With bi-directional isolation the USG is even more robust than the PC-OPTO range.

### NMEA Gateway - NMEA 0183 to NMEA 2000

The NGW product range converts NMEA 0183 sentences into NMEA 2000 messages and vice-versa. The NMEA 0183 end comes in standard NMEA 0183 bare wire connections or with a USB plug to connect directly to a PC running NMEA 0183 software.

Please visit the [Actisense](#) product webpage for full details on these and other **Actisense** interfacing and Depth sounding product ranges including NMEA 2000



## Connecting NMEA talkers to NMEA Listeners

Care needs to be taken when connecting different types of NMEA talkers together, particularly where a mixture of NMEA versions is encountered. These pages show common connections for each type of talker and listener, and how to connect between new type differential devices and old type single-ended devices.

On page 10 and 11, details are given for connecting an on board PC system to an NMEA 0183 network.

### Differential NMEA talker

These are the recommended methods of connection for a differential, NMEA version 2.0 talker.

#### Case (1): Standard differential NMEA 0183 v2.0+ Listener

This device is a differential device conforming in full to the NMEA 0183 v2.0 (or higher) standard, and connects directly to the pins on the differential device.

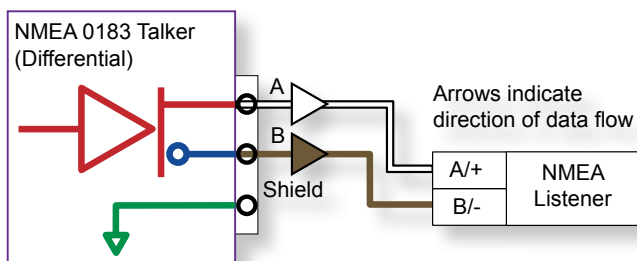

NMEA 0183 version 2 'Differential' Talker connected to NMEA version 2 'OPTO-Isolated' Listener

#### Case (2): Single-ended NMEA Listener

To connect the device to the differential output, connect 'NMEA +/A' to the device's 'NMEA' input and 'Ground' to the 'Ground' on the single ended device. It should be able to receive the NMEA data correctly.

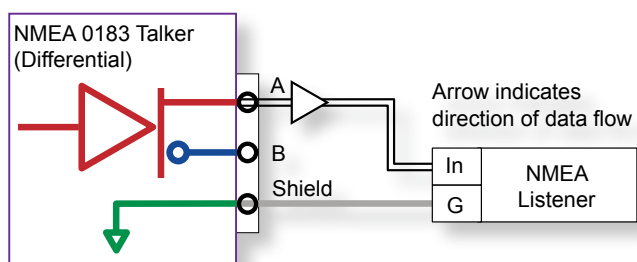

NMEA 0183 version 2 'Differential' Talker connected to NMEA version 1 'Single-ended' Listener

**Never** connect the 'NMEA -/B' to the ground of a single ended receiving instrument. The resulting extra load will at best increase the current consumption of the driver, at worst it could cause serious damage to it.

## Single-ended NMEA talker

These are the recommended methods of connection for a single-ended, pre - NMEA version 2.0 talker.

Many instruments that output version 2.0 formatted strings use a single-ended output. This is often the case with some of the hand-held GPS units such as from Garmin, as the circuitry to produce the differential output is more complex, and requires extra connector pins.

Single ended outputs are normally labelled 'NMEA Tx', 'NMEA Out' or just 'Data'. The ground connection is used as the data signal reference.

### Case (1): Standard differential NMEA 0183 v2.0+ device

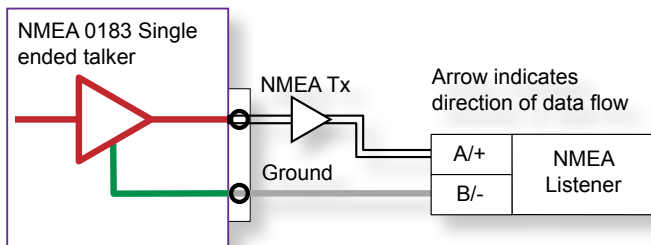

NMEA 0183 'Single-Ended' Talker connected to NMEA 'OPTO-Isolated' Listener

This device is a differential device conforming in full to the NMEA 0183 v2.0 (or higher) standard.

Its "NMEA +/A" input is connected to the "NMEA Tx" output of the single ended device. Its "NMEA -/B" input is connected to the "Ground" of the single ended device. This connection is required to provide data signal return current path for the opto-isolated NMEA listener. If the NMEA "-/B" input is left floating, then data corruption / errors may occur, or more likely, no data will be seen.

### Case (2): Single ended NMEA interface devices

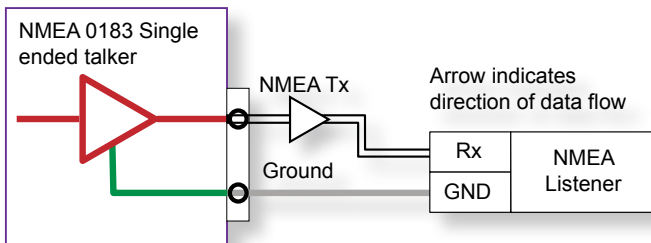

NMEA 0183 'Single-Ended' Talker connected to NMEA 0183 'Single Ended' Listener

This device is a single ended listener. This listener is simply connected as "NMEA Out / Data or Tx" to "(NMEA) In / Rx" and "Ground" to "Ground" of the single ended device

## Connecting a computer to an NMEA 0183 network

A very common requirement now is to connect a PC or Laptop computer to the marine data network. As the NMEA specification basically uses the same asynchronous Comms specification in accordance with ANSI standard as used on a standard PC serial port, most PC's can read NMEA directly through their Comms port.

Many installations have been performed where the NMEA 0183 data signal of a talker is connected to the computer RS232 "Rx" line, and the ground of the talker to the Computer "Ground" connection. *Do not connect the NMEA Talker "B" line to the PC ground.*

### Straight-through / extension cable

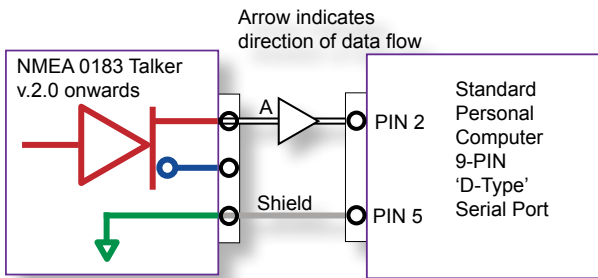

A functional but not-recommended method often used to connect a PC or Laptop to a marine network.

### Null modem cable

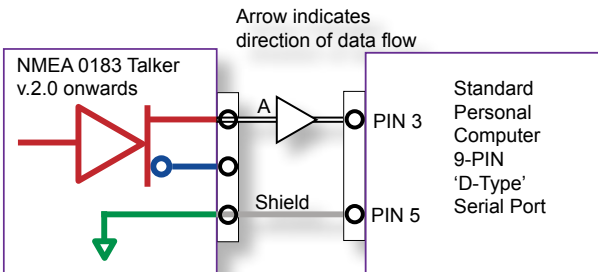

A functional but not-recommended method often used to connect a PC or Laptop to a marine network using a null modem cable.

In our experience, almost 100% of PC's will show the data of the NMEA link with this simple connection.

**Both of these are dangerous and most definitely not recommended**, as high voltage spikes can be present on the signal cable, by induction from motors, alternators, radar pulses, high power radios etc. and will damage the Comms port on a laptop or PC that has only been designed for domestic use. Particularly large voltage spikes can occur when engines switch on and off - outboard motors are often very hazardous to the quality of electrical signals on board a boat.

Often, this connection will function for months with no problem, then fail at the worst possible time. This has

even happened to our lab PCs in controlled conditions. We now always use opto-isolators on our test benches (see below).

Connecting directly to the computer RS232 port also breaks the NMEA 0183 requirement for opto-isolation between Talker and Listener; therefore there may be warranty conditions to this effect on equipment sold for marine use.

This opto-isolation requirement was created to prevent ground loops within an NMEA 0183 network - this can be

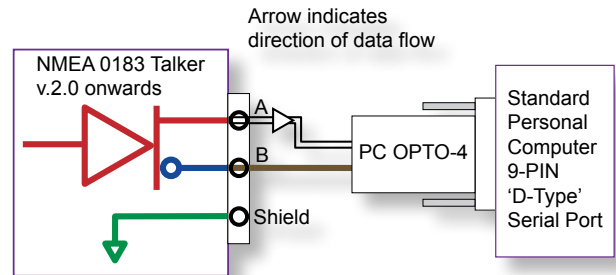

Recommended connection of a PC or Laptop to a talker

a bigger problem than the high voltage spikes, as ground currents can destroy a PC by allowing amps of current to flow through the delicate printed circuit boards within.

It is also often the case that the PC is powered by an on board mains supply, derived from an inverter. Connecting an NMEA 0183 data signal to a PC serial port directly may connect the ground of the inverter to the ground of the ship's battery. This would cause a "ground-loop" issue.

## Recommended method for connecting a PC to an NMEA 0183 Network

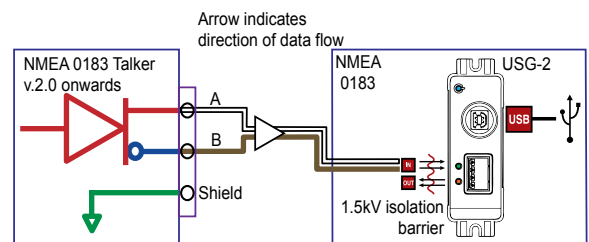

Connecting a PC or Laptop USB port safely to a marine network  
Note the isolated output of the USG-2 allows safe driving of the marine bus from the PC

To safely interface to an NMEA 0183 network on a boat, it is best to obtain an opto-isolated NMEA to RS232 adapter cable (see the Actisense PC-OPTO range). Simply plug the PC-OPTO into the PC port and connect the open end wires to the NMEA 0183 lines.

## Connection of a PC with no serial port to an NMEA 0183 network

There are two ways to do this - you can purchase a USB to serial adapter, which creates a serial connection from a USB port and connect to the PC-OPTO as above.

Better still is to use an Actisense USG USB to serial Gateway. This creates a totally isolated RS422 driver and receiver ready to connect safely to any NMEA 0183 network

## Testing an NMEA 0183 computer connection with Actisense NMEA Reader

**NMEA Reader** is free software for PC users to easily monitor and debug NMEA data. Capable of displaying both NMEA 0183 and NMEA 2000 data NMEA Reader can be an invaluable tool for installing an NMEA network.

## Example data using an Actisense talker device

By connecting a so-called "Triducer" from a company like **Airmar ([www.airmar.com](http://www.airmar.com))**, or direct from the **Actisense**, it is possible to measure the four quantities of depth, speed, log (distance) and temperature in just one device with a considerable cost saving versus buying each transducer/device separately. Plus, all this data is supplied through just one NMEA 0183 port.

The Actisense **DST** (active depth sounder module) has the same Digital Signal Processor unit, but can connect to any analogue Triducer (Depth, Speed & Temperature), Biducer (Depth & Temperature), or Depth only transducer. It allows easy conversion of the analogue transducer signals into the digital NMEA 0183 sentences.

These two sensor types output the NMEA strings 'DBT', 'DPT', 'MTW', 'VHW' and 'VLW'.

Why do the strings have these names, and what data do they contain? Refer to the **NMEA 0183 Sentence Format** section of this document for more details.

## NMEA 0183 Sentence Format

All NMEA 0183 data is sent in the form of text sentences, each beginning with a '\$' or '!' symbol, and use commas to separate each part of the sentence. NMEA codes are plain 'ASCII' text, and have the following format:

```
$yyXXX,..... *xx <0D><0A>
```

- The sentence always starts with a '\$' or '!' symbol
- A 2-digit 'yy' code follows, giving the instrument type (e.g. for a GPS device this should be 'GP', and for a depth sounder this should be 'SD')
- A 3-digit 'XXX' code follows, giving the sentence data type (e.g. 'GGA' is a 'Global Positioning System Fix Data' sentence, and 'DBT' is a 'Depth Below Transducer' sentence)
- A comma follows, then the contents of the sentence data, which changes depending on the data type and the current values of what is being monitored.
- The final part is an optional two-digit checksum - optional, but all good equipment will include this to help safe-guard the data in the sentence. The checksum is preceded by the '\*' character and is calculated by taking the 8-bit exclusive-OR of all characters in the sentence, including ',' delimiters, between but not including the '\$' / '!' and '\*' delimiters.
- The string always ends with a carriage return and line-feed combination (Hex 0D 0A, ASCII '\r\n')

To better explain the NMEA 0183 format, the next section details all the NMEA 0183 sentences output by the Actisense DST unit. The 3-digit 'XXX' is replaced by the 3-digit codes presented below.

In the data format below, the values DATA\_#### represents the digital data, and can have any number of digits before and after the decimal point (if included). This makes the system compatible with all levels of required output precision, depending on the ability of the sensor.

Some data fields are optional – i.e. can be left out, by having no data between the comma delimiters.

The checksums shown are for example purposes only and will only be correct with a particular combination of data.

It would not be feasible to copy out the entire specification here, but there is more data on further strings in the links section at the end of this document.

## DBT – Depth Below Transducer

Water depth referenced to the transducer's position. Depth value expressed in feet, metres and fathoms.

Format:

```
$xxDBT,DATA_FEET,f,DATA_METRES,M,
DATA_FATHOMS,F*hh<0D><0A>
```

### Examples

Standard precision, without checksum:

```
$SDDBT,6.6,f,2.0,M,1.1,F<0D><0A>
6.6 feet / 2.0 metres / 1.1 fathoms.
```

Extended precision, without checksum:

```
$SDDBT,6.66,f,2.03,M,1.10,F<0D><0A>
6.66 feet / 2.03 metres / 1.11 fathoms.
```

Standard precision, with checksum:

```
$SDDBT,8.1,f,2.4,M,1.3,F*0B<0D><0A>
8.1 feet / 2.4 metres / 1.3 fathoms.
```

```
$SDDBT,8.1,f,2.4,M,,<0D><0A>
```

8.1 feet / 2.4 metres / No fathom output.

## DPT – Depth

Water depth relative to the transducer, the depth offset of the transducer, and maximum depth that the sounder can detect a sea-bed (all in metres only).

Positive offsets provide distance from the transducer to the water line. Negative offsets provide distance from the transducer to the keel.

Not all NMEA 0183 devices that output this sentence can have their depth offset changed. In this case, the depth offset will always be zero, or not included.

NMEA 0183 v2.0 sentences will not include the maximum depth range value at all, as it was added in v3.0.

Format:

```
$xxDPT,DATA_METRES,OFFSET_METRES,
MAXIMUM_METRES*hh<0D><0A>
```

### Examples

Standard precision, without checksum:

```
$SDDPT,76.1,0.0,100,<0D><0A>
76.1 metres, zero depth offset, 100 metres maximum
depth range.
```

Standard precision, with checksum:

```
$SDDPT,2.4,,*7F<0D><0A>
2.4 metres, no depth offset or maximum depth range
output (When depth offset and maximum depth values are
unknown by the depth sounder).
```

## MTW – Mean Temperature of Water

Water temperature in degrees centigrade.

Format:

```
$xxMTW,DATA_TEMPERATURE_C,C*hh<0D><0A>
```

### Example

Extended precision, with checksum:

```
$YXMTW,17.75,C*5D<0D><0A>
```

17.75 degrees centigrade.

## VHW – Water Speed and Heading

The compass heading to which the vessel is currently pointing, and the speed of the vessel through the water.

Format:

```
$xxVHW,DATA_HEADING_DEGRESS_TRUE,T,  
DATA_HEADING_DEG_MAGNETIC,M,  
DATA_SPEED_KNOTS,N,  
DATA_SPEED_KMH*hh<0D><0A>
```

### Example

Standard precision, with checksum:

```
$VWVHW, , , , 0.0,N,0.0,K*4D<0D><0A>
```

No heading data provided (as not available), Water speed 0.0 Knots, and 0.0 Km/h.

## VLW – Dual Ground/Water Distance

The distance travelled by the vessel, relative to the water and over the ground. Trip distances are the distances travelled since this value was last reset, thereby resetting at the beginning of a trip, the trip distance is given.

Not all NMEA 0183 device that output this sentence can have their trip distance reset - in this case, a power reset will reset both distances.

Format:

```
$xxVLW,DATA_TOTAL_WATER_DISTANCE_NM,N,  
DATA_TRIP_WATER_DISTANCE_NM,N,  
DATA_TOTAL_GROUND_DISTANCE_NM,N,  
DATA_TRIP_GROUND_DISTANCE_NM,N  
*hh<0D><0A>
```

### Example

```
$VWVLW,2.8,N,2.8,N*4C
```

Total water distance travelled 2.8 nautical miles, and Trip water distance 2.8 NM (since last reset). The ground distance values are not included and as the checksum has been used to terminate the sentence, the comma and 'N' characters of the ground values do not need to be included in the sentence.

This fore-shortening of the sentence by using the checksum can be used in any NMEA 0183 sentence.

## NMEA Version 3 Approved Sentence Formatters

This list shows how the three letter formatters expand into a more meaningful description of the contents of the NMEA 0183 sentence. To discover the contents of the actual sentences, you must purchase the standard from the NMEA (refer to the [NMEA Contact Information](#)).

Many other sentence formatters exist, that were specified for previous version of the NMEA 0183 standard, but this list is the current list recommended by the NMEA - all other formatters are effectively "retired" and should not be adopted on new designs.

AAM	Waypoint Arrival Alarm	MLA	GLONASS Almanac Data
ABK	UAIS Addressed and binary broadcast acknowledgement	MSK	MSK Receiver Interface
ACA	UAIS Regional Channel Assignment Message	MSS	MSK Receiver Signal
ACS	UAIS Channel management information Source	MTW	Water Temperature
AIR	UAIS Interrogation Request	MWD	Wind Direction and Speed
ALM	GPS Almanac Data	MWV	Wind speed and Angle
ALR	Set Alarm State	OSD	Own Ship Data
APB	Heading/Track Controller (Autopilot) Sentence "B"	RMA	Recommended Minimum Specific Loran-C Data
BEC	Bearing and Distance to Waypoint – Dead Reckoning	RMB	Recommended Minimum Navigation Information
BOD	Bearing – Origin to Destination	RMC	Recommended Minimum Specific GNSS Data
BWC	Bearing and Distance to Waypoint	ROT	Rate of Turn
BWR	Bearing and Distance to Waypoint – Rhumb Line	RPM	Revolutions
BWW	Bearing – Waypoint to Waypoint	RSA	Rudder Sensor Angle
CUR	Water Current Layer	RSD	Radar System Data
DBT	Depth Below Transducer	RTE	Routes RTE – Routes
DCN	Decca Position	SFI	Scanning Frequency Information
DPT	Depth	SSD	UAIS Ship Static Data
DSC	Digital Selective Calling Information	STN	Multiple Data ID
DSE	Expanded Digital Selective Calling	TLB	Target Label
DSI	DSC Transponder Initialize	TLL	Target Latitude and Longitude
DSR	DCS Transponder Response	TTM	Tracked Target Message
DTM	Datum Reference	TUT	Transmission of Multi-language Text
FSI	Frequency Set Information	TXT	Text Transmission
GBS	GNSS Satellite Fault Detection	VBW	Dual Ground/Water Speed
GGA	Global Positioning System Fix Data	VDR	Set and Drift
GLC	Geographic Position – Loran C	VHW	Water Speed and Heading
GLL	Geographic Position – Latitude/Longitude	VLW	Dual Ground/Water Distance
GMP	GNSS Map Projection Fix Data	VPW	Speed – Measured Parallel to Wind
GNS	GNSS Fix Data	VSD	UAIS Voyage Static Data
GRS	GNSS Range Residues	VTG	Course Over Ground and Ground Speed
GSA	GNSS DOP and Active Satellites	WCV	Waypoint Closure Velocity
GST	GNSS Pseudo range Error Statistics	WNC	Distance – Waypoint to Waypoint
GSV	GNSS Satellites in View	WPL	Waypoint Location
HDG	Heading, Deviation and Variation	XDR	Transducer Measurements
HDT	Heading, True	XTE	Cross-Track Error, Measured
HMR	Heading Monitor Receive	XTR	Cross-Track Error – Dead Reckoning
HMS	Heading Monitor Set	ZDA	Time and Date
HSC	Heading Steering Command	ZDL	Time and Distance to Variable Point
HTC	Heading/Track Control Command	ZFO	UTC and Time from Origin Waypoint
HTD	Heading/Track Control Data	ZTG	UTC and Time to Destination Waypoint Encapsulation Formatters
LCD	Loran-C Signal Data	ABM	UAIS Addressed binary and safety related message
LRF	UAIS Long-Range Function	BBM	UAIS Broadcast Binary Message
LT1	UAIS Long-Range Interrogation	VDM	UAIS VHF Data-link Message
LR1	UAIS Long-Range Reply Sentence 1	VDO	UAIS VHF Data-link Own-vessel report
LR2	UAIS Long-Range Reply Sentence 2		
LR3	UAIS Long-Range Reply Sentence 3		

## NMEA Contact Information

NMEA - National Marine Electronics Association  
7 Riggs Avenue  
Severna Park,  
MD  
21146  
USA



Telephone: +1 (410) 975 9422  
Fax: +1 (410) 975 9450

E-mail: [info@nmea.org](mailto:info@nmea.org)  
Website: [www.nmea.org](http://www.nmea.org)

## Company Information

**Active Research Limited**  
5, Wessex Trade Centre  
Ringwood Road  
Poole  
Dorset  
UK  
BH12 3PF



**Telephone:** 01202 746682 (International : +44 1202 746682)

**Actisense on the Web:** For advice, support and product details

**E-mail:** [support@actisense.com](mailto:support@actisense.com)  
**Website:** [www.actisense.com](http://www.actisense.com)

**Twitter:** [www.twitter.com/ActisenseNews](http://www.twitter.com/ActisenseNews) (All **Actisense** News and Updates)  
[www.twitter.com/ActisenseTech](http://www.twitter.com/ActisenseTech) (**Actisense** Product Updates)  
**Facebook:** <http://on.fb.me/1Kk8Hc7> (All **Actisense** News and Updates)  
**LinkedIn:** [linkd.in/actisense](http://linkd.in/actisense) (All **Actisense** News and Updates)

**“Actisense” is a registered trademark of Active Research Limited.**